

FRONT
SCALE 1 / 2

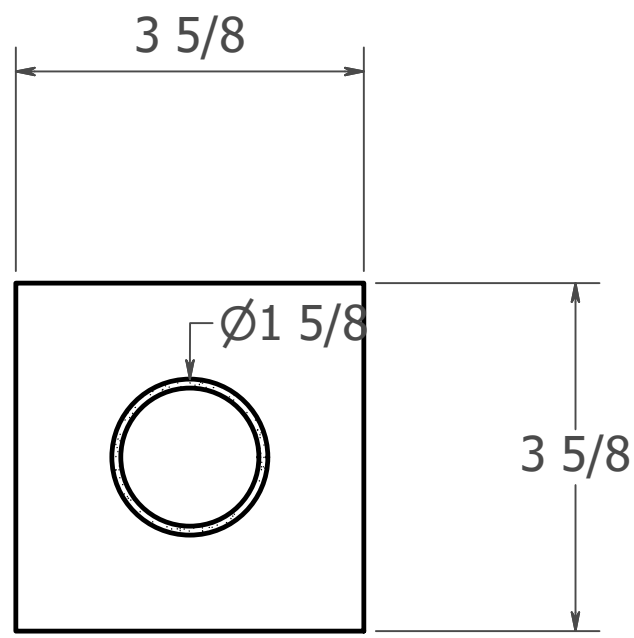

SECTION A-A
SCALE 1 / 2

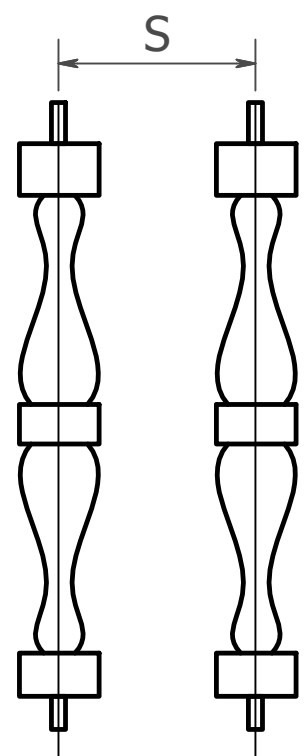

DISTANCE BETWEEN
BALUSTERS = S

S = 5.9375



3D
SCALE 1 / 2

NOTE 1: MEASUREMENTS TAKEN FROM PRODUCTION PARTS.
DRAWINGS MAY VARY SLIGHTLY FROM ACTUAL PARTS.

REV	DESCRIPTION	DATE	APVD.

WORTHINGTON
American Made Architectural Products
17842 Ashley Drive, Suite C Panama City Beach, FL 32413
Phone: 800.872.1608 Fax : 850.640.0488
e-mail: Sales@worthingtonmillwork.com
WEB: www.worthingtonmillwork.com

DWG NO: WBAL-2890-24	PART NO: WBAL-2890-24	CLIENT: SIGN	DATE:
DWG BY: DNZ.	DATE: 6/15/2017	TITLE: 24" BALUSTER	
FILED UNDER :	SCALE: SEE ABOVE	REV:	DIM. TOLERANCE :
ALL ITEMS ARE DRAWN FOR PRESENTATION PURPOSES ONLY, THEREFORE IMAGE SHOWN MAY VARY SLIGHTLY FROM FINISHED ACTUAL PART. DRAWING SHOWN IS TO INDICATE GENERAL ARRANGEMENT AND DESIGN. WORTHINGTON RESERVES THE RIGHT TO CHANGE ANY PRODUCT DESIGN WITHOUT NOTIFICATION.			SIZE: C
			PAGE: 1/1