

FRONT
SCALE 1/3

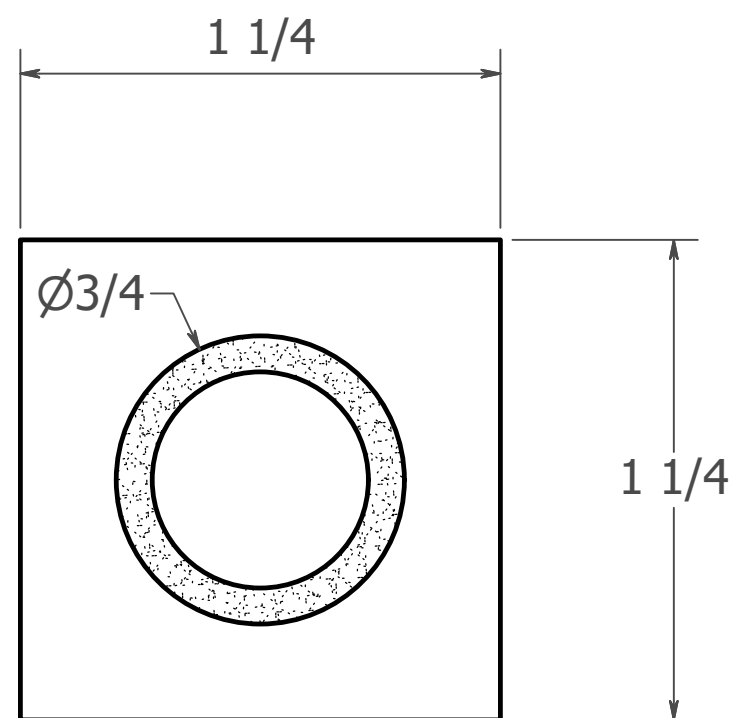

SECTION A-A
SCALE 2 : 1

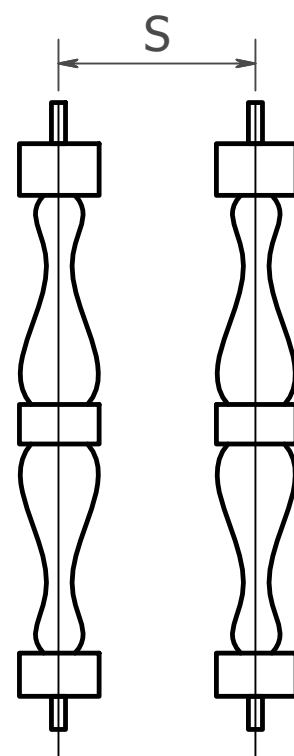

DISTANCE BETWEEN
BALUSTERS = S

S = 5.625

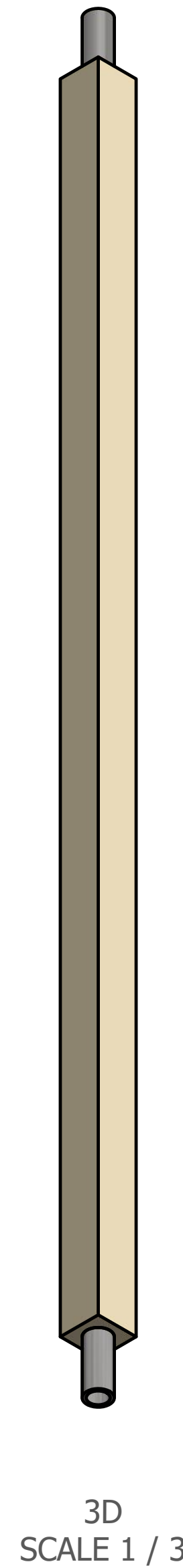

3D
SCALE 1 / 3

NOTE 1: MEASUREMENTS TAKEN FROM PRODUCTION PARTS.
DRAWINGS MAY VARY SLIGHTLY FROM ACTUAL PARTS.

REV	DESCRIPTION	DATE	APVD.

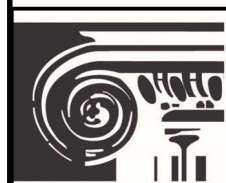
 WORTHINGTON American Made Architectural Products 17842 Ashley Drive, Suite C Panama City Beach, FL 32413 Phone: 800.872.1608 Fax : 850.640.0488 e-mail Sales@worthingtonmillwork.com WEB: www.worthingtonmillwork.com	DWG NO: WBAL-2300-36	PART NO: WBAL-2300-36	CLIENT: SIGN	DATE:	
	DWG BY: DNZ.	DATE: 6/15/2017	TITLE: 36" BALUSTER		
	FILED UNDER :	SCALE: SEE ABOVE	REV:	DIM. TOLERANCE :	SIZE: C
	ALL ITEMS ARE DRAWN FOR PRESENTATION PURPOSES ONLY, THEREFORE IMAGE SHOWN MAY VARY SLIGHTLY FROM FINISHED ACTUAL PART. DRAWING SHOWN IS TO INDICATE GENERAL ARRANGEMENT AND DESIGN. WORTHINGTON RESERVES THE RIGHT TO CHANGE ANY PRODUCT DESIGN WITHOUT NOTIFICATION.				PAGE: 1/1