

FRONT  
SCALE 1/3

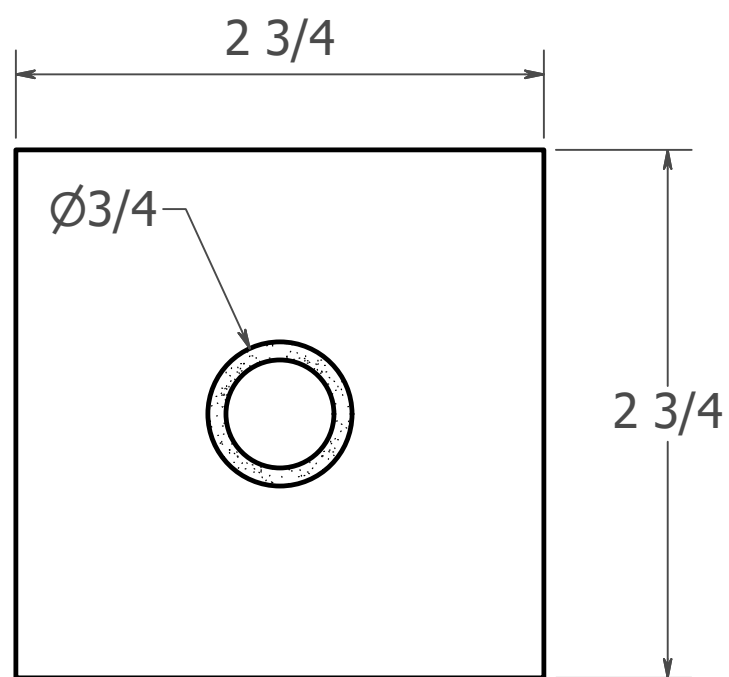

SECTION A-A  
SCALE 1 : 1

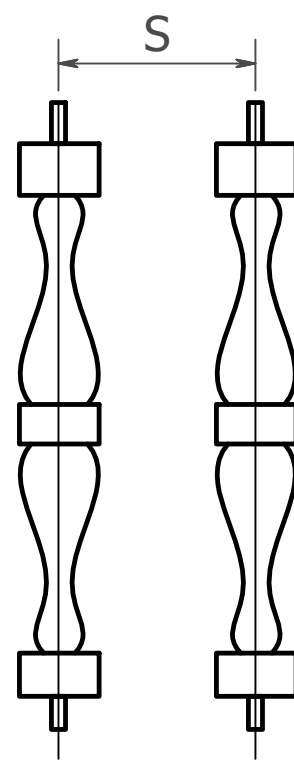

DISTANCE BETWEEN  
BALUSTERS = S

**S = 5.4375**



3D  
SCALE 1 / 3

NOTE 1: MEASUREMENTS TAKEN FROM PRODUCTION PARTS.  
DRAWINGS MAY VARY SLIGHTLY FROM ACTUAL PARTS.

REV	DESCRIPTION	DATE	APVD.

**WORTHINGTON**<sup>®</sup>  
American Made Architectural Products  
17842 Ashley Drive, Suite C Panama City Beach, FL 32413  
Phone: 800.872.1608 Fax : 850.640.0488  
e-mail: [Sales@worthingtonmillwork.com](mailto:Sales@worthingtonmillwork.com)  
WEB: [www.worthingtonmillwork.com](http://www.worthingtonmillwork.com)

DWG NO: WBAL-1700-28	PART NO: WBAL-1700-28	CLIENT: SIGN	DATE:
DWG BY: DNZ.	DATE: 6/15/2017	TITLE: 28" BALUSTER	
FILED UNDER :	SCALE: SEE ABOVE	REV:	DIM. TOLERANCE :
ALL ITEMS ARE DRAWN FOR PRESENTATION PURPOSES ONLY, THEREFORE IMAGE SHOWN MAY VARY SLIGHTLY FROM FINISHED ACTUAL PART. DRAWING SHOWN IS TO INDICATE GENERAL ARRANGEMENT AND DESIGN. WORTHINGTON RESERVES THE RIGHT TO CHANGE ANY PRODUCT DESIGN WITHOUT NOTIFICATION.			SIZE: C
			PAGE: 1/1